



FOBA tripod heads. The camera-tripod safety link.

FOBA tripod heads – quality made in Switzerland

Among a wide range of professional studio equipment for photographers, the Swiss company FOBA supplies four different tripod ball head lines offering optimal stability, ergonomics and safety.

FOBA TILTING HEADS are built for the heaviest cameras up to 8x10" format, allowing precise positioning and secure locking. The FOBA SUPERBALL head is the most popular of the FOBA range. With its elegant design and sturdy construction, this head is ideal for all cameras

All FOBA ball heads and all FOBA tilt-heads can be inclined more than 90° from the vertical axis. Consequently, pictures of objects on both camera positions can be taken easily.



ASNEO clamp mount with long tube for repro shoots



FOBA-SUPERBALL: for medium and large-format cameras



FOBA SUPERBALL® (BALLA)

Same features as BALLO. With the quick-release mounting (BALSO), it offers maximum convenience and optimal security (two removable safety plugs). A wide variety of camera plates is available, all of which can remain on the camera. Appropriate for small-, medium-format and especially for professional cameras.

Diameter:	76 mm
Height:	130 mm
Weight:	1400 g (3 lbs)
Load capacity:	15 kg (33 lbs)



BALPO

Camera plate with 1/4" and 3/8" threads (BALPO). Fixed to FOBA SUPERBALL with two Phillips screws.

Diameter:	76 mm
Height:	8 mm
Weight:	50 g (0.11 lbs)

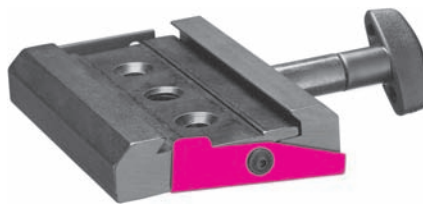

BALSO

Quick-release mounting for FOBA SUPERBALL. Takes various quick-release plates. With two removable safety plugs.

Length:	84 mm
Width (without locking screw):	60 mm
Height:	15 mm
Weight:	120 g (0.26 lbs)



FOBA SUPERBALL® (BALLO)

With its advanced technology is one of the most popular tripods among professional photographers. It is equipped with a friction clamp and a locking lever. Together with a reversible camera plate, threaded 1/4" and 3/8", it has a 360° panorama calibrated in degrees and a separate locking screw. Appropriate for small-, medium-format and especially for professional cameras.

Diameter:	76 mm
Height:	130 mm
Weight:	1320 g (2.9 lbs)
Load capacity:	15 kg (33 lbs)



BALTO

Panorama plate for installation between camera plate and FOBA SUPERBALL. Full 360° rotation, calibrated in degrees, with clamping screw.

Diameter:	76 mm
Height:	20 mm
Weight:	250 g (0.55 lbs)

The following quick release plates are available for BALSO quick release unit:

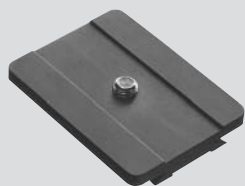

BALPU

Quick-release plate with 3/8" thread for quick-release unit BALSO for SUPERBALL (fits also other FOBA quick-release units)

Length:	80 mm
Width:	60 mm
Height:	11 mm
Weight:	110 g (0.24 lbs)

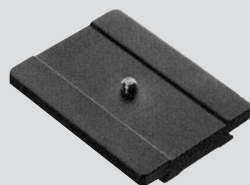

BALPI

Quick-release plate with 1/4" thread for quick-release unit BALSO for SUPERBALL (fits also other FOBA quick-release units)

Length:	80 mm
Width:	60 mm
Height:	11 mm
Weight:	110 g (0.24 lbs)

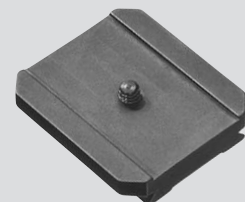

BALTE

Quick-release plate with Hasselblad mounting and 1/4" thread for quick-release unit BALSO for SUPERBALL (fits also other FOBA quick-release units).

Length:	57 mm
Width:	50 mm
Height:	11 mm
Weight:	90 g (0.20 lbs)

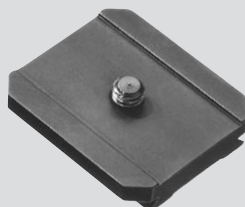

BALPE

Quick-release plate with Hasselblad mounting and 3/8" thread for quick-release unit BALSO for SUPERBALL (fits also other FOBA quick-release units).

Length:	57 mm
Width:	50 mm
Height:	11 mm
Weight:	90 g (0.20 lbs)

FOBA MINI SUPERBALL: for medium and small-format cameras

The smaller FOBA MINI SUPERBALL is the perfect tripod mounting for small and medium format cameras.

Both the FOBA SUPERBALL and MINI SUPERBALL are available either with camera plate or quick-release unit.



FOBA MINI SUPERBALL® (BALLI)

Has the same technology as the FOBA SUPERBALL in a smaller version. Interchangeable camera plate with 1/4" and 3/8" mounting screws. Large, high precision spherical head, handy friction clamp and locking lever. Appropriate for small- and medium-format cameras.

Diameter:	64 mm
Height:	110 mm
Weight:	580 g (1.28 lbs)
Load capacity:	12 kg (26.5 lbs)

FOBA MINI SUPERBALL® PLUS (BALMI)

Same features as FOBA MINI SUPERBALL, but additionally with a 360° panoramic adapter calibrated in degrees and a separate locking screw. Appropriate for small- and medium-format cameras.

Diameter:	64 mm
Height:	115 mm
Weight:	740 g (1.63 lbs)
Load capacity:	12 kg (26.5 lbs)



BALTA

Panorama adapter for MINI SUPERBALL®.

Diameter:	64 mm
Height:	23.5 mm
Weight:	230 g (0.51 lbs)



BALSJ

Quick-release unit (BALSJ) for FOBA MINI SUPERBALL®, with two removable safety plugs. Takes various quick-release plates.

Length:	60 mm
Width (without locking screw):	60 mm
Height:	15 mm
Weight:	120 g (0.26 lbs)



FOBA MINI SUPERBALL® (BALLU)

Same features as BALLI; with well-ried FOBA quick-release unit (BALSJ) for various camera plates. The quick-release unit has two removable safety plugs to prevent the camera sliding off. Appropriate for small- and medium-format cameras.

Diameter:	64 mm
Height:	105 mm
Weight:	630 g (1.39 lbs)
Load capacity:	12 kg (26.5 lbs)



FOBA MINI SUPERBALL® PLUS (BALMU)

Same features as BALMI but with quick-release unit (BALSJ). Appropriate for small- and medium-format cameras.

Diameter:	64 mm
Height:	120 mm
Weight:	820 g (1.81 lbs)
Load capacity:	12 kg (26.5 lbs)

The following quick release plates are available for FOBA quick release units:

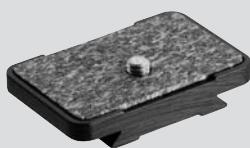

BALPA

Short quick-release plate with small-format camera mounting and 1/4" thread (fits all FOBA quick-release units); topping thread for 3/8" also available.

Length:	40 mm
Width:	60 mm
Height:	11.5 mm
Weight:	55 g (0.12 lbs)

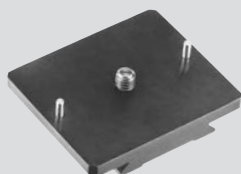

BALMA

Quick-release plate with Mamiya mounting and 1/4" thread (fits all FOBA quick-release units); topping thread for 3/8" also available.

Length:	50 mm
Width:	60 mm
Height:	10 mm
Weight:	60 g (0.13 lbs)



BALME

Topping thread of 1/4" to 3/8", as well as 3/8" to 1/4" adapter. Set of 5 pieces.



BALGI

Adapter to connect stands and cameras with different connection threads.

Upper screw thread:	1/4"
Lower inner thread:	3/8"
Height:	23 mm
Diameter:	67 mm
Weight:	220 g (0.5 lbs)



BALMO

Camera plate with 1/4" and 3/8" threads. Fixes to FOBA MINI SUPERBALL® with two screws.

Diameter:	54 mm
Height:	8 mm
Weight:	50 g (0.11 lbs)

FOBA SUPERBALL M-Line: The small ball head that delivers high performance ...

The M-Line is the «Light weight» of the SUPERBALL family. Lasting precision and functionality mark the key features of the ball heads of the M-Line. The heads guarantee optimum stability, ergonomic operation and maximum clamping force and are designed to withstand many years of use under harsh everyday conditions. The FOBA SUPERBALL® M-Line is ideal for 35 mm SLR and medium-format cameras and ensures both precise camera movement and reliable locking.



SUPERBALL® M-2 (BOLLA)

Same features as BOLLO, but with quick-release unit. The quick-release unit has on one side a very easily manipulated adjustment (tilting) and on the other side it is removable. Appropriate for small- and medium-format cameras.

Diameter:	56 mm
Height:	95 mm
Weight:	550 g (1.21 lbs)
Load capacity:	12 kg (26.5 lbs)

SUPERBALL® M-2 (BOLLO)

Including camera plate 1/4" (topping thread for 3/8" also available). For 35 mm and medium-format cameras. Very compact and sturdy application. New clamping system (first step friction, second step clamping).

In order for photography to please you even more, the locking lever can be folded downwards.

With full 360° panoramic rotation calibrated in degrees and separate locking screw; incl. adapter 3/8" on 1/4" for tripods.

Diameter:	56 mm
Height:	83 mm
Weight:	440 g (0.97 lbs)
Load capacity:	12 kg (26.5 lbs)

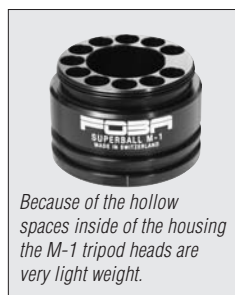

Because of the hollow spaces inside of the housing the M-1 tripod heads are very light weight.

SUPERBALL® M-1 (BENTO)

Same features as BENTA, but with quick-release unit. Appropriate for small- and medium-format cameras.

Diameter:	52 mm
Height:	110 mm
Weight:	405 g (0.89 lbs)
Load capacity:	8 kg (17.6 lbs)



SUPERBALL® M-1 (BENTA)

Including camera plate with 1/4" thread (topping thread 3/8" also available). For 35 mm and medium-format cameras.

Multifunctional locking system, high clamping force (4,5 kg / 10 lbs - for a lever length of 300 mm), full 360° panoramic rotation, 3/8" and 1/4" thread adapter for tripods.

Diameter:	52 mm
Height:	90 mm
Weight:	275 g (0.6 lbs)
Load capacity:	8 kg (17.6 lbs)

FOBA tilting heads

The tilt axes are fixed or released by eccentric clamps. This ingenious mechanism has many advantages:

- only a small amount of rotating force is needed to produce a great tension force and thus to stop the tilt axes securely
- the tilt axes can be fixed in rotating the rotary handle in both directions
- About a quarter of a turn is needed for the fixation or the releasing, allowing efficient installing and working conditions.



FOBA Tilting Head (ASMIO)
with one tilt axis through over 90° and panorama plate mounted on needle bearings; incl. 3/8" and 1/4" tripod screws. The tilting axis is effortlessly fixed by powerful eccentric clamp. Especially appropriate for medium- and large-format cameras.

Diameter of panorama:	80 mm
Height (when camera is horizontal)	110 mm
Weight:	1150 g (2.54 lbs)
Load capacity:	20 kg (44 lbs)



BALSU
Quick release unit incl. SLR-plate BALPA. With shifting device and two removable safety plugs. Takes various quick-release plates. Fits all tripod heads. Topping thread for 3/8" also available.

Length:	60 mm
Width (without locking screw):	61.5 mm
Height:	21 mm
Weight:	175 g (0.39 lbs)



FOBA Dual Tilting Head (ASMIA)
with two tilt axes through over 90° and panorama plate mounted on needle bearings; incl. 3/8" and 1/4" tripod screws. The tilting axes are effortlessly fixed by powerful eccentric clamp. Especially appropriate for medium- and large-format cameras.

Diameter of panorama:	80 mm
Height (when camera is horizontal)	115 mm
Weight:	1750 g (3.8 lbs)
Load capacity:	20 kg (44 lbs)



STADI
Block with cable-fix. To be screwed on the bottom of the camera. It prevents the cables to be torn from the camera.

Length without lateral screw:	175 mm
Upper thread:	1/4"
Lower thread:	1/4" and 3/8"
Weight:	280 g



BALGO
Base plate for mounting tripod heads on floor or tabletop.

Screw with thread:	3/8"
Corner dimension:	235 mm
Height:	19 mm
Weight:	900 g (1.98 lbs)



The very handy cable-fix STADI prevents the tearing out of the cables from the camera when shooting by freehand.





ASNAO

Camera mounting for clamp mounting.

Weight: 450 g (0.99 lbs)



ASNEU

Additional tube for ASNEO clamp mounting. To be either mounted on clamping piece or screwed as an extension on existing tube.

Usable length: 27 cm
Weight: 340 g (0.75 lbs)



CESTU

Camera plate with 1/4" and 3/8" threads for mounting camera on FOBA COMBITUBE®.

Diameter of camera plate: 54 mm
Height without screw thread: 56 mm
Diameter of the hole: 25 mm
Weight: 190 g (0.42 lbs)

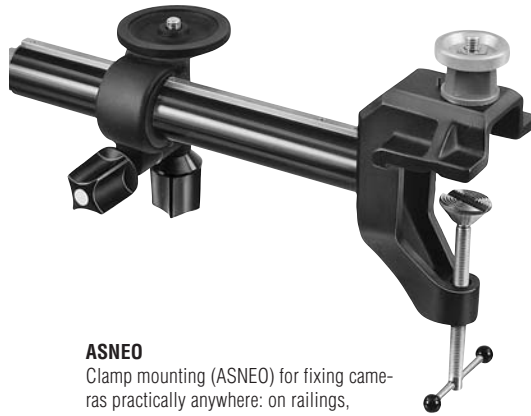

ASNEO

Clamp mounting (ASNEO) for fixing cameras practically anywhere: on railings, ladders, window frames, tables etc. This accessory is extremely useful for open-air photography in difficult situations where normal 3-legged tripods cannot be used. The ASNEA clamp and ASNAO camera mounting are also available separately. The tube can be mounted on the clamping piece as well as horizontally or vertically.

Length of tube: 300 mm
Weight complete: 1450 g (3.2 lbs)



ASNEA

Clamp for clamp mounting. Max. aperture: 73 mm for flat assemblies and for 60 mm diameter tubes.

Weight: 670 g (1.48 lbs)



Base plate and COMBITUBE elements used as stand for tripod head and camera.

for more details about the handy COMBITUBE-system check out www.foba.com

FOBA[®]
STUDIO-TECHNOLOGY

FOBA AG
Studio-Technology
Friedgrabenstrasse 21
CH-8907 Wettswil

+41 44 701 90 00
+41 44 701 90 01

info@foba.com
www.foba.com

FOBA product lines:

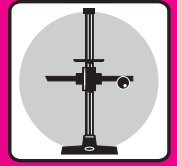

FOBA STUDIO STANDS, TRIPODS
FOBA STATIVE
FOBA PIÈDS À COLONNE, TRÉPIEDS



FOBA TRIPOD HEADS
FOBA STATIVKÖPFE
FOBA TÊTES DE TRÉPIEDS

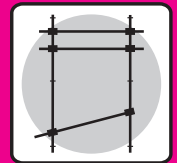

FOBA CEILING RAIL SYSTEM
FOBA DECKENSCHIENEN-SYSTEM
FOBA SYSTÈME RAILS DE PLAFOND

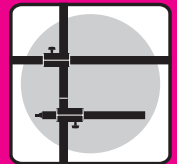

FOBA COMBITUBE SYSTEM
FOBA COMBIROHR® SYSTEM
FOBA SYSTÈME COMBITUBE



FOBA SHOOTING TABLES
FOBA AUFNAHMETISCHE
FOBA TABLES DE PRISE DE VUE

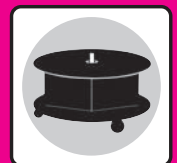

FOBA TURNTABLES
FOBA DREHTELLER
FOBA TABLES TOURNANTES